

Cadence Tutorial 2: Schematic Entry 8-bit Ripple Carry Adder

EE577b Fall98

Refer http://www-scf.usc.edu/~ee577b/tutorial/cadence_tut.html

jsmoon@ISI.EDU

1. Tutorial Setup

1. Make sure you have "source ~ee577/setup.csh" entry in your .cshrc file or .login file.
2. Go to your working directory
`%cd cds`
3. Prepare basic gates library.
 - 1) If you have your own cell library, skip this procedure.
 - 2) If you don't complete tutorial 1 or want to use library by your TA, add the following line in your cds.lib file.
`DEFINE Cell /auto/home-scf-06/ee577/CDS/Cell`
4. Invoke "icds" program at your working directory ("cds")
5. Create "Adder8" library using the same procedure shown in "2. Create Library" of Tutorial 1.

jsmoon@ISI.EDU

2. Create HA Schematic and Symbol

1. Complete the following schematic called "half_adder" using basic gates. Library for "half_adder" would be "Adder8".

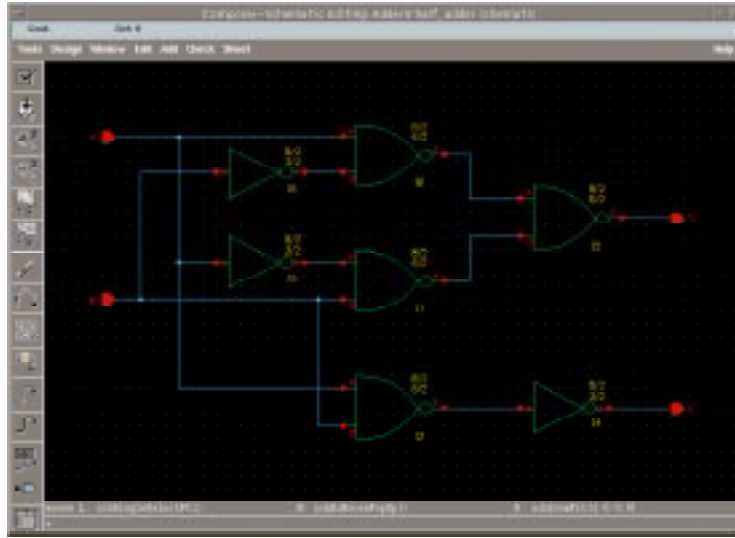

jsmoon@ISI.EDU

2. Create HA Schematic and Symbol (continued..)

2. Create half_adder symbol automatically
 sch:Design->Create Cellview->From Cellview
 The form defaults indicate the Adder8 library,
 half_adder cell and creation of the symbol from the schematic.
 Click OK. (Use default)



[Symbol Generation Options] window will appear. You can control pin locations at your own. I would rather to use default.

Symbol for half_adder will be generated automatically and appear in symbol editor.

- If you assign input and output pins in schematic, you can generate symbol automatically in this way.
- You can modify the symbol in symbol editor if you wish.

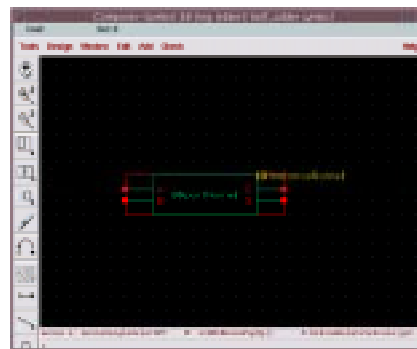

jsmoon@ISI.EDU

3. Create FA Schematic and Symbol

1. Complete the following schematic called "full_adder" using basic gates and half_adder. Library for "full_adder" would be "Adder8".

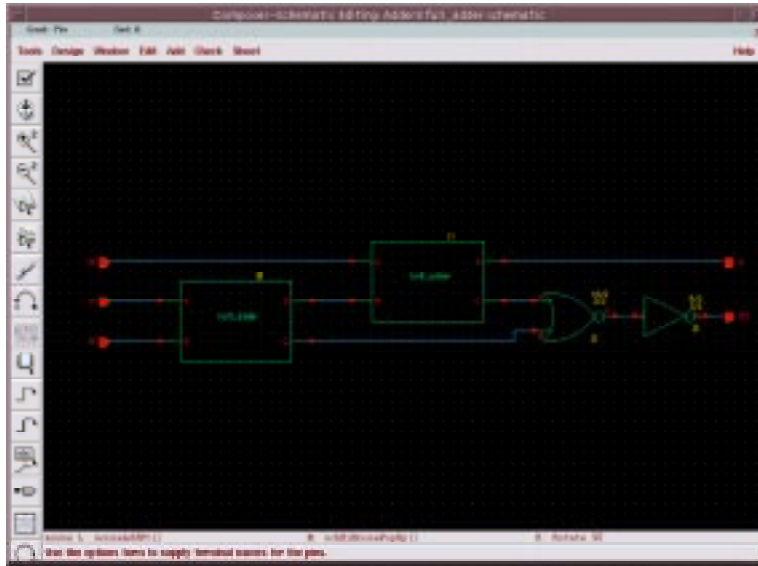

2. Create full_adder symbol automatically or manually.

jsmoon@ISI.EDU

4. Create 8-bit Adder Schematic

You will create an 8-bit adder multisheet schematic. You will create the schematic with 4-bits on sheet 1, 4-bits on sheet 2.

1. Open a new schematic called "adder8" with library "Adder8"
2. Make multisheet drawing by
`sch:Sheet->Make Multisheet`
 In [Make Multisheet] window, enter the following
 Number : 1
 Size : none
 Type : basic
 Click Apply (First sheet is created)
`sch:Sheet->Create`
 In [Create Schematic Sheet] window, enter the following.
 Number : 2
 Size : none
 Type : basic
 Click Apply (Now we have two sheet for this schematic)
`sch:Sheet->Go To`
 Click "First" to open the first sheet.
3. Complete the first schematic as shown below. (without any labels or pins)

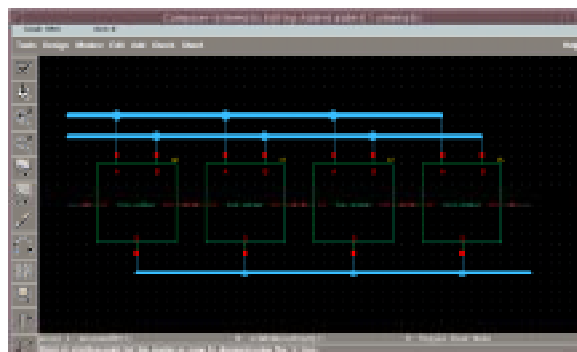
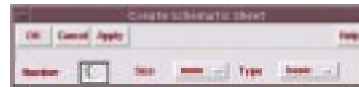

jsmoon@ISI.EDU

4. Create 8-bit Adder Schematic (continued..)

4. Add Pins as shown in the table below.

Pin Name	Pin Direction	Pin Usage
A<7:0>	input	schematic
B<7:0>	input	schematic
Cin	input	schematic
C3	output	offSheet
S<3:0>	output	offSheet

schematic : External Pins
offSheet : Pins connecting to other sheets

5. Add bus tap labels using bus expansion.
Select Wire Name from the toolbox (or "I")
In [Add Wire Name] window,
Names : <0:3*3>
Bus Expansion : on
Placement : multiple
The following labels will be generated
with these Add Wire name form:
<0><0><0><1><1><1> ... <3><3><3>
Place them on A<3:0>,B<3:0>,S<3:0> tabs.

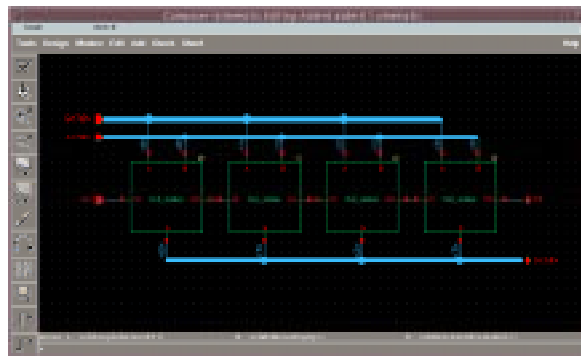
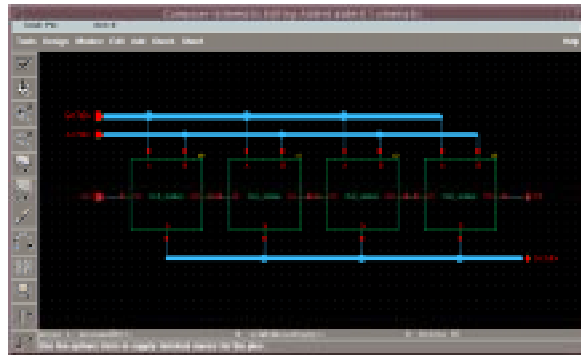
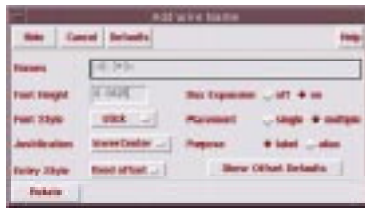

jsmoon@ISI.EDU

4. Create 8-bit Adder Schematic (continued..)

6. Complete the second schematic as shown below.

If you want to copy the first sheet and modify pins and label,

Open "adder1@sheet1" schematic.

Select the whole schematic using mouse.

sch>Edit->copy

In sheet1, select the reference point for the copy by clicking "mouse L".

Move the mouse pointer into the sheet2 window and click "mouse L" again for the copy.

Change pins properties as shown in the following table

Pin Name	Pin Direction	Pin Usage
A<7:0>	input	offSheet
B<7:0>	input	offSheet
C3	input	offSheet
Cout	output	schematic
S<7:0>	output	schematic

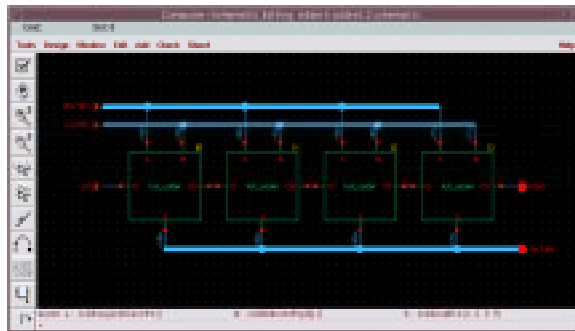

jsmoon@ISI.EDU